

Contents ---

One		
Introduction		2
Two		
Installation		3
Front Panel		
Connecting Ports		
LEDs		
Three		
Configuration and Installation Guidelines		7
Hub/Network Configuration		
Ports and Connectors		
Typical Use for the Megaswitch® 10		
Changing the Default Configurations		
Cable Schematic		
Four		
Troubleshooting and Technical Reference		12
Appendix		
Technical Support		14

1 Introduction

The Megaswitch® 10 is a stand-alone 10/100base switching hub utilising automatic self learning technology to enhance its switching performance. Unlike a repeater hub, it can route data packets directly from port to port without holding up any of the other ports, so avoiding congestion.

The Megaswitch® 10 enables users to upgrade their existing Ethernet networks and connect local workgroups to a Fast Ethernet structure, interconnecting centrally located servers and enabling faster throughput.

The Installation and operation are simple. In case of difficulties consult the troubleshooting guide and technical specifications at the back of this manual.

Features

The Ringdale **Megaswitch® 10** Hub provides the following features:

8 x 10base-T ports.

2 x 10/100base-TX MDI-X ports.

1 x MDI port for hub to hub connection with straight-through patch cable.

Full duplex support on all ports.

Extensive front panel diagnostic LEDs.

Auto-learns network configuration.

100 Mbps throughput for high-performance data transfer.

Low port-port latency minimises delay during data transfer.

No software to load or configure.

2 Installation

Connect the power cord to the socket on the rear panel of the hub and plug into power supply.

The **Power** LED lights up and the hub is ready for operation.

Front Panel

The 10/100base switching hub front panel contains all the necessary network connectors and LEDs required for the connection and operation of the hub.

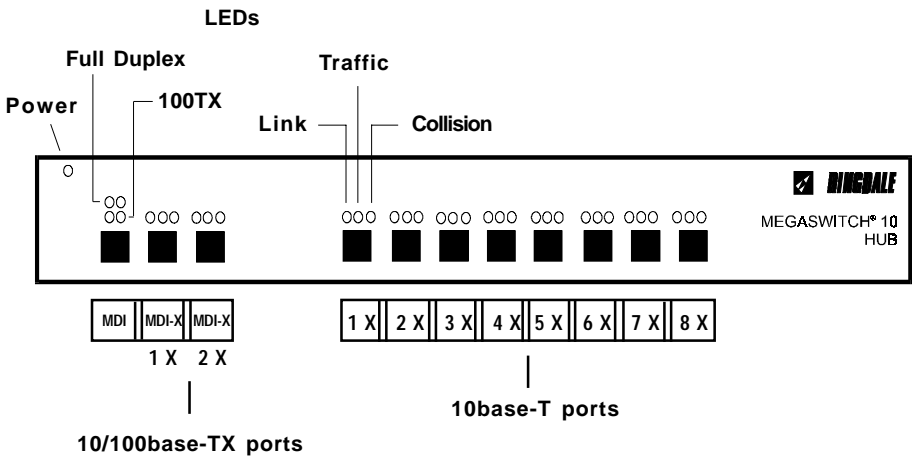

Connecting ports

Connecting Devices to the Megaswitch® 10

Simply insert the RJ45 cables from the required devices into the ports, the specifications for each port are detailed above. Ensure that RJ45 cabling is wired up for Ethernet.

The ports support direct connection to any 10/100baseTX compatible adapter using Category 5 UTP cabling.

After all devices are connected, the hub can be installed on to the rest of the network.

Connecting the Megaswitch® 10 to Other Hubs.

The **MDI(Media Dependant Interface)** port is specifically for connecting the Megaswitch® 10 to other Ethernet/Fast Ethernet hubs. Only one connection between hubs is allowed.

Note: When the MDI socket is connected to a hub, the 1 X MDI-X port becomes inoperative.

When this connection is complete, the Megaswitch® 10 should be fully functional and its operation can be monitored using the front panel diagnostic LEDs.

LEDs

The **Power** LED lights when the Megaswitch® 10 is connected to a power source.

Each port has 3 monitoring LEDs.

The **Link** LED indicates that the port is functionally connected to an external port. It lights up when the connected adapters and the hub are turned on. If the LED does not light up, there may be a problem with the cabling or the adapter in the workstation or server.

The **Traffic** LED shows activity on each port. The LED blinks on receipt of a data packet, regardless of the status of the port - even if the port is disabled.

The **Collision** LED blinks when two or more packets are sent to the port simultaneously. When this occurs the packets are rejected before being sent again.

There are additional LEDs for the MDI/MDI-X ports.

As explained earlier, either the MDI port or the 1 X MDI-X port can be selected, but both cannot be used at the same time. This means that the LEDs above the 1 X MDI-X port will function either for that port or for the MDI port, whichever is in use. Similarly, the **Full Duplex** and **100TX** LEDs above the MDI port will operate for whichever of the two ports is being used.

The diagram below demonstrates how to read this configuration of LEDs.

The first column of LEDs above the MDI port refers to the MDI port or the 1 X MDI-X port, whichever is in use

The second column of LEDs refers to the 2 X MDI-X port

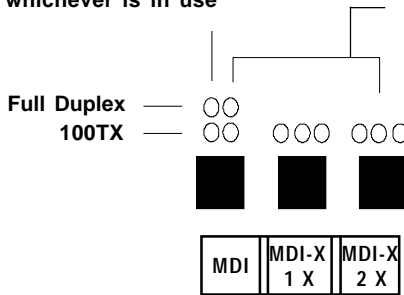





10/100base-TX ports

The **Full Duplex** LED indicates when the port is connected to a network running as Full Duplex.

The **100TX** LED indicates that the port is connected to a 100base-TX Fast Ethernet network

Examples of possible configurations of LEDS above MDI Port.

Below is a table showing some of the possible LED configurations depending on the kind of connections to the 10/100base-TX ports.

10 or 100 base	Full or Half Duplex	Port	Configuration
100b	F	MDI/1 X MDI-X	
100b	H	2 X MDI-X	
10b	F	2 X MDI-X	
10b	H	MDI/1 X MDI-X	

The Installation completed, the hub should now be fully integrated into the network and the operation of the Megaswitch® 10 can be fully monitored.

3 Configuration and Installation Guidelines

This section provides general guidelines on how to use the Megaswitch® 10 and how to fit it into your existing network.

The Megaswitch® 10 can be installed where existing bridges, hubs, routers and servers are located.

A typical location for the Megaswitch® 10 would be close to the data-centre, fileservers or computer room. It can also be installed in an office environment, however, it should be located within 100 metres of the attached server(s) and workstations.

Fast Ethernet ports and installations require UTP Category 5 cabling. UTP cables are sensitive to electrical noise, so ensure that your cabling is not near electrical noise such as fluorescent lights or power lines.

Ensure that the RJ45 cable is wired for Ethernet! Straight-through cables are used to connect adapters in servers or workstations.

The server or the workstations must have 100base TX compatible adapters (interfaces) installed.

Hub/Network Configuration

Attached servers and workstations can be connected to the hub by UTP cables of less than 100 metres and two hubs can be connected from node to node as long as the distance through the hubs is less than 210 metres.

This figure is arrived at because the maximum distance, including the equivalent distance of the hub between two nodes, on a Fast Ethernet network

is 400 metres. A Fast Ethernet hub is equivalent to 95 metres of cable, which gives under the *210 metre rule* the following calculation:

Cable	1st	2nd	Cable
Length	Hub	Hub	Remaining
400 M	-	95 M	-
		95 M	=
			210 M

Ports and Connectors

The Megaswitch® 10 ports use standard RJ45 connectors. The arrangement of the pins and the pinouts are shown in these figures together with the configuration of the twisted-pair cabling.

Position connector with gold contacts uppermost.

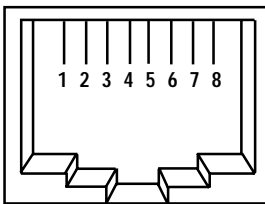

Port

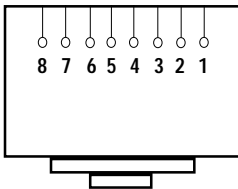

Cable
Connector

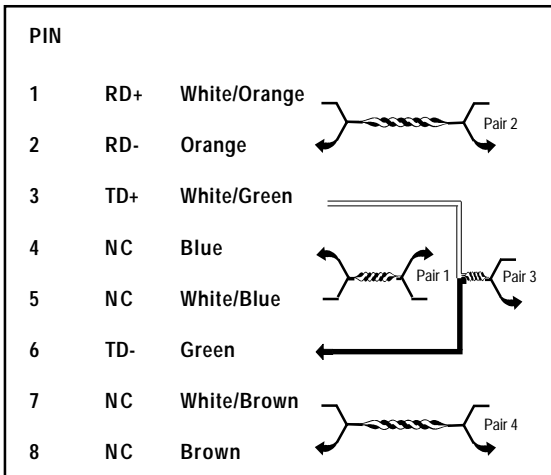

100Base-TX uses Pairs 2 and 3.

100Base-T4 and 100VG use pairs 1,2,3 and 4.

Typical use for the Megaswitch® 10

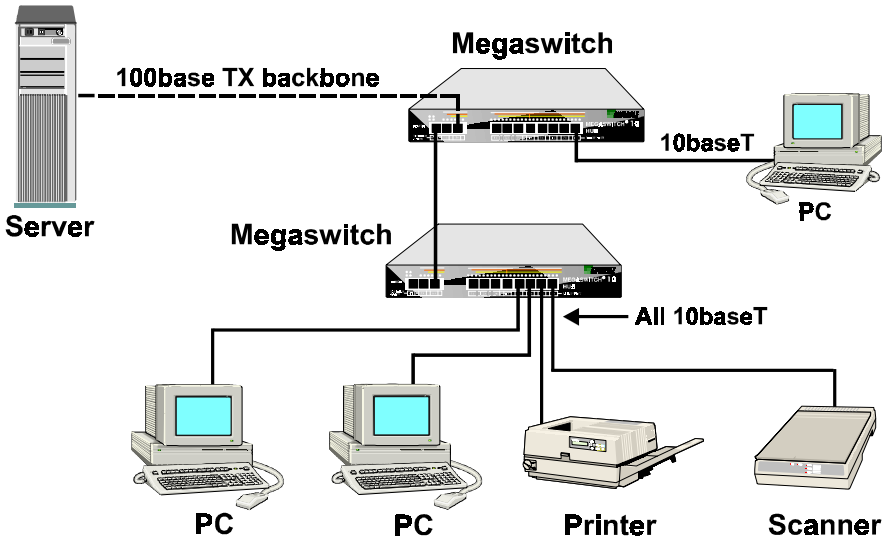

Changing the Default Configurations of the Megaswitch® 10

On the back panel of the Megaswitch® 10 is a **25 way d type parallel connector port**. This enables access to and changing of the default configurations of the hub via a PC, if required.

Connect the cable between the port at the back of the hub and to the PC you wish to use for the configuration (**Note**: it is advised that the PC used for this procedure is not connected to a network).

Load the **Megaset** program supplied on the floppy disk included with the Megaswitch® 10.

Click twice on the **Desktop** icon in the top left of the Megaset program screen. Then click twice on **Configure**.

Selecting the **System** tab from the displayed options will bring up the page below. It shows the configurations that can be changed on the hub. Simply click on the box required to activate/deactivate the listed configuration.

The screenshot shows the 'System' tab selected in a network management interface. The interface has a green background and a white border. At the top, there are four tabs: 'System', 'Ports', 'VLAN', and 'Direct'. Below the tabs, there is a list of configuration options, each with a checkbox. To the right of the list, there are two additional controls: 'Arbitration Priority' with radio buttons for 'Transmit' and 'Receive', and 'RAM size' with a text input field containing '256K' and up/down arrow buttons.

Configuration Option	Status
Enable Long Frames	<input type="checkbox"/>
Use Alternate Statistic Mapping	<input type="checkbox"/>
Disable Ports on Security Violations	<input type="checkbox"/>
Cut Through On 100MBS Only	<input checked="" type="checkbox"/>
Broadcast to Unassigned Ports	<input checked="" type="checkbox"/>
Use ThunderPhy(tm) Interface	<input type="checkbox"/>
Limit Learning on Port 0	<input type="checkbox"/>
Use EAM (External Address Matching)	<input type="checkbox"/>
Enable LED TX activity for non-unicast frames	<input type="checkbox"/>
Enable Post Frame Tagging	<input type="checkbox"/>
Enable Flow Control	<input type="checkbox"/>
Enable DIO Test Registers	<input type="checkbox"/>

Arbitration Priority: Transmit, Receive

RAM size: 256K

Selecting the **Ports** tab from the displayed options will bring up the page below. It shows the configurations that can be changed on the hub specific for each port. Simply click on the box required to activate/deactivate the listed configuration for each of the ports (P0-P9).

The screenshot shows the 'Ports' tab selected in a network management interface. The interface has a green background and a white border. At the top, there are four tabs: 'System', 'Ports', 'VLAN', and 'Direct'. Below the tabs, there is a table of configuration options for ports P0 through P9. Each option has a row of checkboxes, one for each port. The 'Store & Forward on Transmit' and 'Store & Forward on Receive' options are checked for all ports.

Configuration Option	P0	P1	P2	P3	P4	P5	P6	P7	P8	P9
Disable Port:	<input type="checkbox"/>	<input type="checkbox"/>	<input type="checkbox"/>	<input type="checkbox"/>	<input type="checkbox"/>	<input type="checkbox"/>	<input type="checkbox"/>	<input type="checkbox"/>	<input type="checkbox"/>	<input type="checkbox"/>
MII Nibble Mode:	<input checked="" type="checkbox"/>	<input checked="" type="checkbox"/>	<input type="checkbox"/>	<input type="checkbox"/>	<input type="checkbox"/>	<input type="checkbox"/>	<input type="checkbox"/>	<input type="checkbox"/>	<input type="checkbox"/>	<input type="checkbox"/>
Disable Address Matching:	<input type="checkbox"/>	<input type="checkbox"/>	<input type="checkbox"/>	<input type="checkbox"/>	<input type="checkbox"/>	<input type="checkbox"/>	<input type="checkbox"/>	<input type="checkbox"/>	<input type="checkbox"/>	<input type="checkbox"/>
Force Half Duplex:	<input type="checkbox"/>	<input type="checkbox"/>	<input type="checkbox"/>	<input type="checkbox"/>	<input type="checkbox"/>	<input type="checkbox"/>	<input type="checkbox"/>	<input type="checkbox"/>	<input type="checkbox"/>	<input type="checkbox"/>
Enable Transmit Pacing:	<input type="checkbox"/>	<input type="checkbox"/>	<input type="checkbox"/>	<input type="checkbox"/>	<input type="checkbox"/>	<input type="checkbox"/>	<input type="checkbox"/>	<input type="checkbox"/>	<input type="checkbox"/>	<input type="checkbox"/>
Store & Forward on Transmit:	<input checked="" type="checkbox"/>	<input checked="" type="checkbox"/>	<input checked="" type="checkbox"/>	<input checked="" type="checkbox"/>	<input checked="" type="checkbox"/>	<input checked="" type="checkbox"/>	<input checked="" type="checkbox"/>	<input checked="" type="checkbox"/>	<input checked="" type="checkbox"/>	<input checked="" type="checkbox"/>
Store & Forward on Receive:	<input checked="" type="checkbox"/>	<input checked="" type="checkbox"/>	<input checked="" type="checkbox"/>	<input checked="" type="checkbox"/>	<input checked="" type="checkbox"/>	<input checked="" type="checkbox"/>	<input checked="" type="checkbox"/>	<input checked="" type="checkbox"/>	<input checked="" type="checkbox"/>	<input checked="" type="checkbox"/>
MII-Force Full Duplex:	<input type="checkbox"/>	<input type="checkbox"/>	<input type="checkbox"/>	<input type="checkbox"/>	<input type="checkbox"/>	<input type="checkbox"/>	<input type="checkbox"/>	<input type="checkbox"/>	<input type="checkbox"/>	<input type="checkbox"/>
MII-Force 10MB:	<input type="checkbox"/>	<input type="checkbox"/>	<input type="checkbox"/>	<input type="checkbox"/>	<input type="checkbox"/>	<input type="checkbox"/>	<input type="checkbox"/>	<input type="checkbox"/>	<input type="checkbox"/>	<input type="checkbox"/>
MII-Force 100MB:	<input type="checkbox"/>	<input type="checkbox"/>	<input type="checkbox"/>	<input type="checkbox"/>	<input type="checkbox"/>	<input type="checkbox"/>	<input type="checkbox"/>	<input type="checkbox"/>	<input type="checkbox"/>	<input type="checkbox"/>

Fast Ethernet Cable Schematic

The shell for each connector is fixed to the chassis ground. The ports have their receive and transmit pairs internally crossed for attachment to an adapter using a straight-through cable. Schematics are shown below.

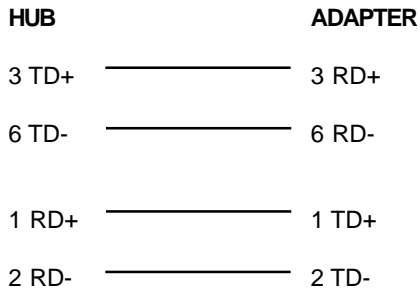

STRAIGHT-THROUGH SCHEMATIC

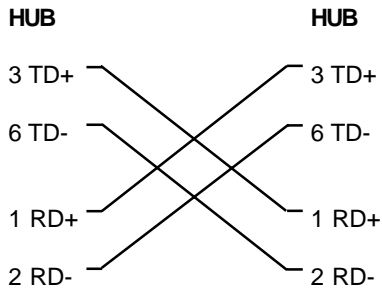

CROSSOVER CABLE SCHEMATIC

4 Troubleshooting and Technical Reference

Symptom	Poss. Cause	Action
Power LED does not light up	Power switched off	Switch on
	Power cord not connected	Plug in hub
	Fuse defect	Replace fuse
Link LED does not light up	No cable inserted	Connect to hub and Interface
	Interface (device) not powered up	Check power supply for devices
	Wrong cable type	Verify cable selection
	Bad cable	Replace cable
	Cable too long	Recalculate cable length

Technical Specifications

10/100base-T automatic self-learning switching hub

Mains:	Input: 90...240V – AC Frequency: 50...60HZ Power: Max.20 Watts
Switch Ports:	10 8 x 10baseT 2 x 10/100base With full duplex support on all 10 ports
Interfaces:	10baseT and 100baseTX compliant standard via MIC interface RJ-45 ports for UTP CAT5 or STP wiring
Mounting:	19 inch EIA RS310-C or IEC pub 297 rack mountable with integral brackets
Technology:	TI chipset using store-and-forward switching method
MAC Address Table:	More than 3000 individual addresses per device
Speed:	100Mbps data rate for high performance data transfer

Appendix Technical Support ---

Ringdale Ltd, Ringdale Inc. and Ringdale GmbH all have Technical Support Departments. Their addresses and contact details are found on the back cover of this manual.

Before you call:

Please have the following information ready before calling:

Type of adapters installed in the System.
The adapter settings and interrupt options.

Network Information:
Network operating system type and version,
server configuration.

LAN topology:
Type of cable being used, size of network,
number of PCs and other nodes in network.

Computer Information:
Manufacturer, model number, operating
system used on the computer.

History of the Problem:
The symptoms of the problem.
Did the hub work for a period of time or fail
immediately after installation?
Was any PC option changed (hardware or
software) prior to the problem appearing?